

QUARTZ CRYSTAL UNITS IN HC-49/S 4PD PACKAGE (4-PINS SMD)

PART NUMBER SYNTAX

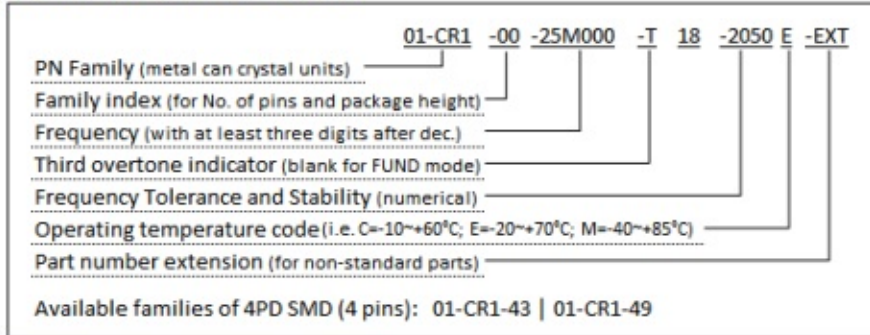

PRODUCT SPECIFICATIONS

Frequency Range (Fo)	3.2MHz to 90.0MHz			
Frequency Tolerance(at 25°C) ($\Delta f/f_0$)	± 50 ppm (typ)	± 30 ppm	± 50 ppm	± 50 ppm
Temperature Stability(REF To 25°C)	± 50 ppm (typ)	± 30 ppm	± 100 ppm	± 100 ppm
Operating Temperature Range (TOPR)	-10°C to 70°C(AT)			0°C to 60°C(BT)
Storage Temperature Range (TSTG)	-40°C to 85°C			
Shunt Capacitance (Co)	7pF Max			
Load Capacitance (CL)	10 to 32pF or Series Resonant			
Insulation Resistance	500 Mega ohms Minimum at 100Vdc			
Drive Level	0.1MW			
Aging(at 25°C)	± 5 ppm/year Max			

EQUIVALENT SERIES RESISTANCE ESR

Frequency Range	Max ESR(Ω)	Mode	Frequency Range	Max ESR(Ω)	Mode
3.200MHz to 3.500MHz	150	Fundamental/AT	8.000MHz to 8.999MHz	60	Fundamental/AT
3.500MHz to 3.999MHz	120	Fundamental/AT	9.000MHz to 9.999MHz	50	Fundamental/AT
4.000MHz to 4.499MHz	100	Fundamental/AT	10.000MHz to 12.999MHz	40	Fundamental/AT
4.500MHz to 4.999MHz	100	Fundamental/AT	13.000MHz to 19.999MHz	30	Fundamental/AT
5.000MHz to 5.999MHz	100	Fundamental/AT	20.000MHz to 30.999MHz	20	Fundamental/AT
6.000MHz to 6.999MHz	70	Fundamental/AT	30.000MHz to 90.000MHz	30	3rd overtone/AT
7.000MHz to 7.999MHz	60	Fundamental/AT	27.000MHz to 40.000MHz	30	Fundamental/BT

MECHANICAL DIMENSIONS [mm]

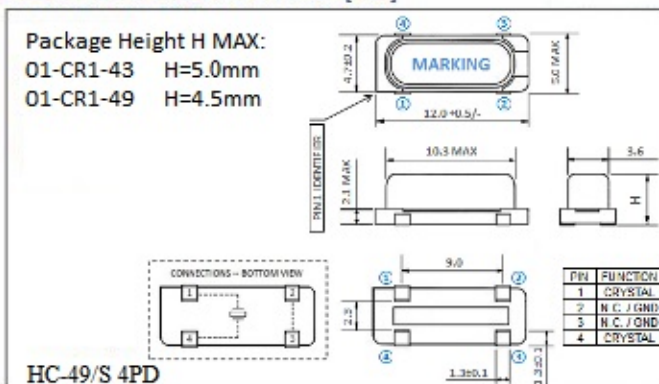

RECOMMENDED REFLOW CONDITIONS

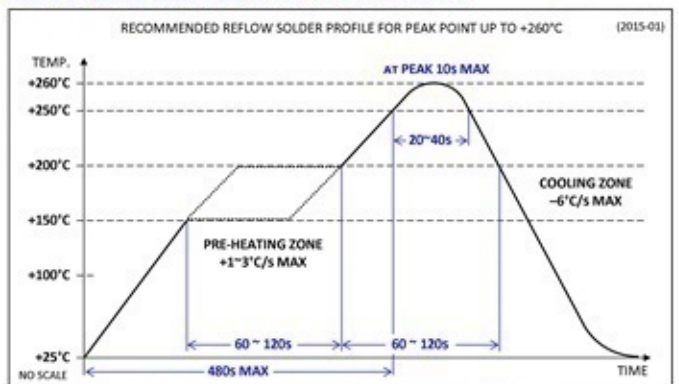

HONG KONG:

NAKAGAWA ELECTRONICS LIMITED

+852 2389 9201 sales@nkg.com.hk
+852 2341 0001 www.nkg.com.hk

China Shenzhen office:

深圳中川晶体电子有限公司

+86(0)755 2598 2648 sales_sz@nkg.cn
+86(0)755 2598 2390 www.nkg.com.hk

China Suzhou office:

苏州纳美电子有限公司

+86(0)512 8818 7890 sales_nm@nkg.cn
+86(0)512 8818 7889 www.nkg.com.hk